

Air valve(5/2 way, 5/3 way)

4A200 Series

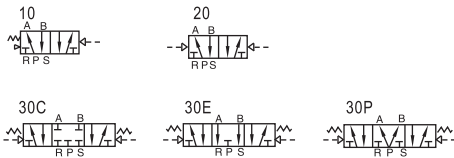

Symbol



Product feature

1. Structure in sliding column mode: good tightness and sensitive reaction.
2. Three position air valves have three kinds of central function for your choice.
3. Double air control valves have memory function.
4. Internal hole adopts special processing technology which has little attrition friction, low start pressure and long service life.
5. No need to add oil for lubrication.
6. Integrate with the manifold to save installation space.

Flow chart

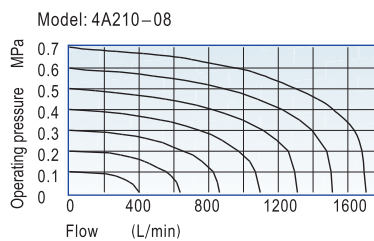
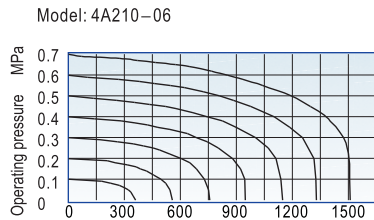

Specification

Model	4A210-06 4A220-06	4A230C-06 4A230E-06 4A230P-06	4A210-08 4A220-08	4A230C-08 4A230E-08 4A230P-08
Fluid	Air(to be filtered by 40 μ m filter element)			
Acting	Exterior control			
Port size ①	In=Out=Exhaust=1/8"		In=Out=1/4" Exhaust=1/8"	
Orifice size	14.0mm ² (Cv=0.78)	12.0mm ² (Cv=0.67)	16.0mm ² (Cv=0.89)	12.0mm ² (Cv=0.67)
Valve type	5 port 2 position	5 port 3 position	5 port 2 position	5 port 3 position
Operating pressure	0.15~0.8MPa(21~114psi)			
Proof pressure	1.5MPa(215psi)			
Temperature °C	-20~70			
Material of body	Aluminum alloy			
Lubrication ②	Not required			
Max. frequency ③	5 cycle/sec	3 cycle/sec	5 cycle/sec	3 cycle/sec
Weight (g)	4A210-06:185 4A220-06:285	365	4A210-08:185 4A220-08:285	365

① PT thread, NPT thread and G thread are available.

② Once lubricated air is used, continue with same medium to optimise valve life span. Lubricants like ISO VG32 or equivalent are recommended.

③ The maximum actuation frequency of no-load state.

Ordering code

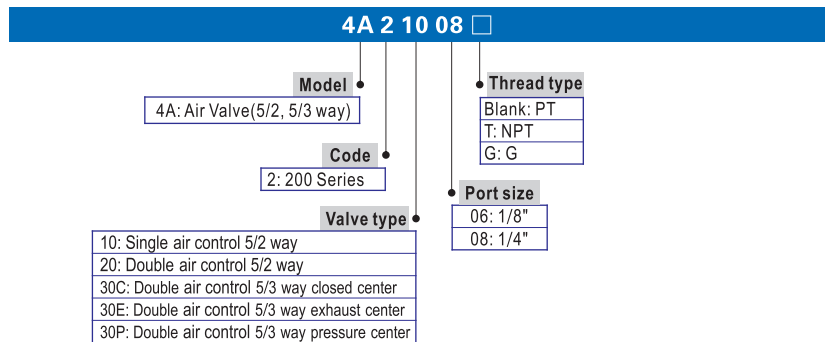

Please refer to 62 for manifold specification and the order way.

Air valve(5/2 way, 5/3 way)

4A200 Series

Inner structure



4A200

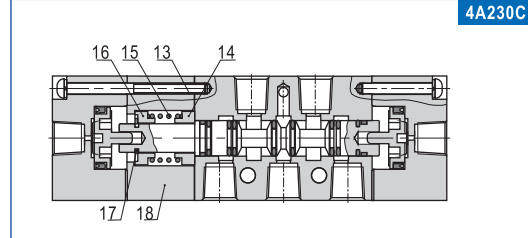
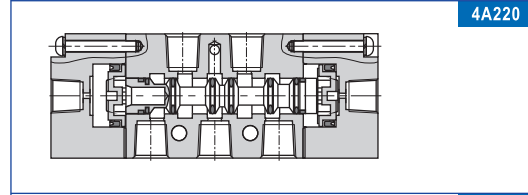
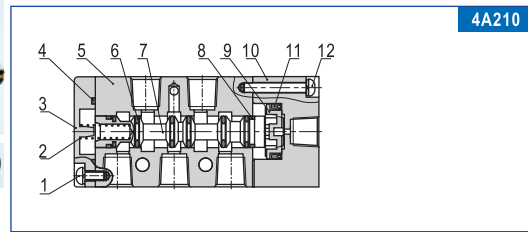

No.	Item	No.	Item	No.	Item
1	Screw	7	Spool	13	Screw
2	Spring	8	Wear ring	14	Spring holder
3	Bottom cover	9	Piston	15	Return Spring
4	Bottom cover gasket	10	Pilot body	16	Spring holder
5	Body	11	O-ring	17	E Clip
6	O-ring	12	Screw	18	Side cover

Dimension

